

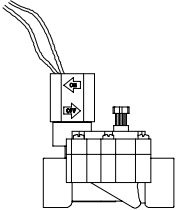
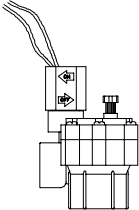
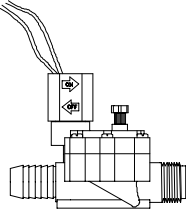
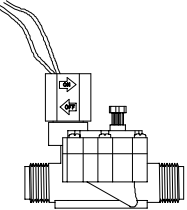
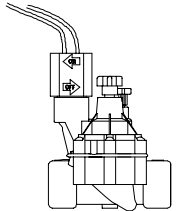
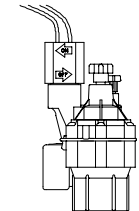
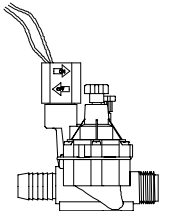
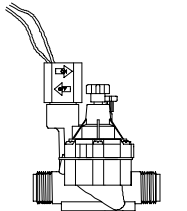

DV & DVF VALVES

GB	DV/DVF Installation Instructions	2
F	Instruction pour l'installation des vannes DV/DVF	4
D	Installationsanleitung für die Ventile DV/DVF	6
I	Istruzioni per l'installazione DV/DVF	8
E	Instrucciones para Instalar el DV/DVF	10
NL	DV/DVF Installatie Handleiding	12
P	Instruções para Instalar o DV/DVF	14

 <p>075-DV: 3/4" (20/27) 100-DV: 1" (26/34) 100-DV-SS: 1" (26/34)</p>	 <p>100-DV-A: 1" (26/34)</p>	 <p>100-DV-MB: 1" (26/34) *125-DV-MB: 1" (26/34)M x 1 1/4" (33/42)B</p>	 <p>100-DV-MM: 1" (26/34)</p>
 <p>100-DVF: 1" (26/34) 100-DVF-SS: 1" (26/34)</p>	 <p>100-DVF-A: 1" (26/34)</p>	 <p>100-DVF-MB: 1" (26/34) *125-DVF-MB: 1" (26/34)M x 1 1/4" (33/42)B</p>	 <p>100-DVF-MM: 1" (26/34)</p>

*NPT only

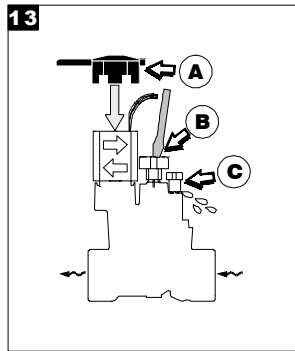
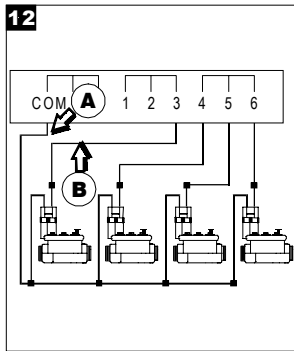
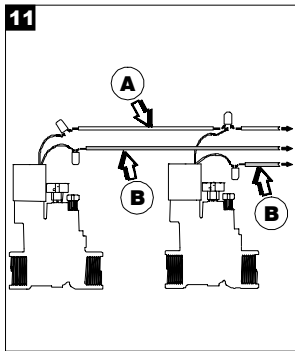
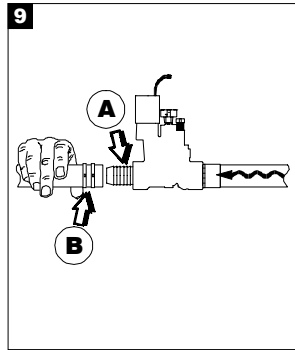
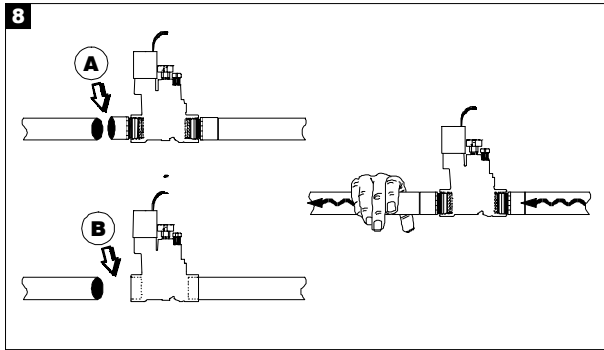
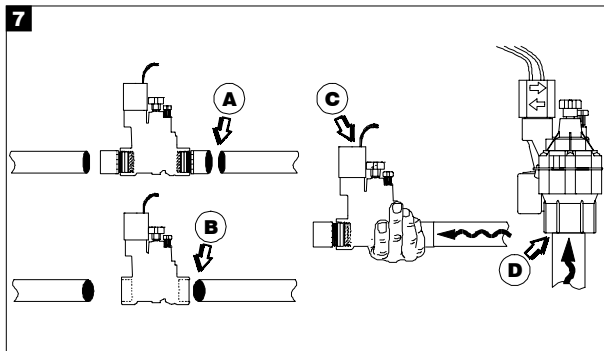
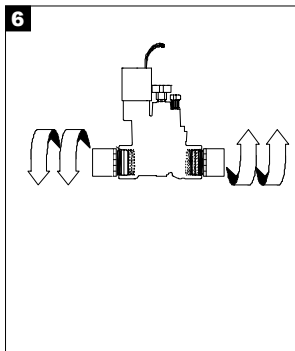
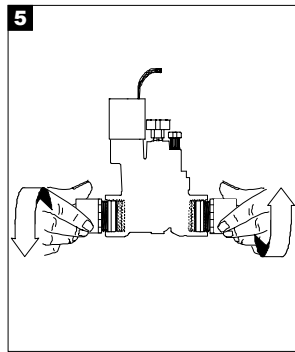
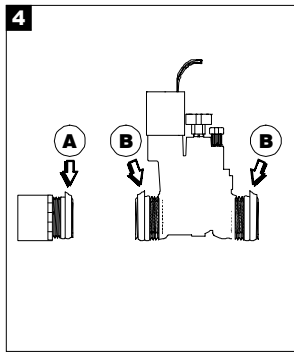
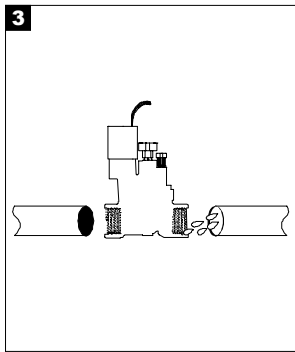

2

Before Installation

1. Make sure you have sufficient water supply, pressure, and flow. Connect pipes to primary water source. refer to the *Rain Bird Irrigation Design Guide*. Refer to local building codes for additional requirements.
2. Install master valves, pressure regulators, and backflow preventers as needed. For system design information,
3. Flush the system thoroughly until the water from the submain runs clear.

Connect Adapters to Valve (Threaded Models Only)

4. To make a watertight seal, wrap 1½ to 2 turns of Teflon tape around the threads on two male x slip adapters (A) or on the male threads of the valve (B; MM and MB models)
 5. Screw the adapters into the valve water ports and hand tighten.
 6. Carefully tighten the adapters one to two additional turns past hand-tight.
- CAUTION:** Do not over-tighten the adapters. You may damage the valve or block the exit ports.

Connect Valve to Pipes

7. Carefully apply a small amount of solvent cement to the inside of the adapter (A, threaded connector) or valve inlet port (B, slip connector). Apply a small amount of cement to the outside of the water supply pipe. Then attach the valve to the pipe. The valve solenoid **MUST** be on the downstream side (C). For DV-A and DVF-A models, connect the supply pipe to the bottom inlet (D).
 8. Cement the lateral pipe to the adapter (A, threaded connector) or valve outlet port (B, slip connector), as described in step 7.
 9. To attach an MB model valve to low-density polyethylene pipe, cut the pipe square and clean. Slip one or two clamps over the poly pipe.
- If necessary, carefully heat the poly pipe for easier installation. Slip the poly pipe completely over the barb (A). Then clamp (B) the pipe securely to the barb for a leak-proof seal.
- CAUTION:** Use only a small amount of solvent cement. Excess cement can damage the valve internally.

Connect Valve Wires

10. Select a wire gauge that meets electrical specifications. Multi-strand, direct-burial wire is recommended. Refer to local building codes for additional requirements. Use a watertight connector to connect the second lead on each valve to a power wire (B). Each power wire must be run separately to the controller.
11. Use a watertight connector to connect one lead on each valve to a common wire (A). Either lead may be used. All valves on the same controller can share the same common wire.
12. Connect the shared common wire (A) to the common terminal on the controller. Connect one power wire from each valve (B) to a station terminal on the controller.

Operate Valve Manually

13. To open the internal bleed, turn the solenoid handle (A) counterclockwise ¼ to ½ turn. Be sure to re-tighten the solenoid completely. Always use the solenoid handle, which is designed to shut the valve off completely and keep it from “weeping.”
- To reduce flow (DVF models only), turn the flow control stem (B) clockwise. Use your fingers or a slot-head screwdriver. To increase flow, turn the stem counterclockwise.
- To open the external bleed, turn the bleed screw (C) counterclockwise two turns. *Use the external bleed to flush the valve when you first start the system.* Turn the screw clockwise to close it.

Operating Ranges

	075-DV	100-DV, 100-DV-MM¹, 100-DV-MB¹, 125-DV-MB¹, 100-DV-A, & 100-DV-SS	100-DVF, 100-DVF-MM¹, 100-DVF-MB¹, 125-DV-MB¹, 100-DVF-A, & 100-DVF-SS
Flow ²	0.2 - 22 GPM (0,05 - 5,0 m ³ /h or 0,01 - 1,39 l/s)	0.2 - 40 GPM (0,05 - 9,08 m ³ /h or 0,01 - 2,52 l/s)	0.2 - 40 GPM (0,05 - 9,08 m ³ /h or 0,01 - 2,52 l/s)
Pressure	15 - 150 psi (1 - 10 Bars)	15 - 150 psi (1 - 10 Bars)	15 - 150 psi (1 - 10 Bars)

¹DV/DVF male x male (MM) and male x barb (MB) are not recommended for flows exceeding 30 GPM (6,8 m³/h or 1,9 l/s).

²For flows below 3 GPM (0,75 m³/h or 0,21 l/s), or any Landscape Drip application, use RBY-100-200MX filter installed upstream.

Troubleshooting

Symptom	Solution
Valve won't shut off completely. Sprinklers "weep."	Tighten the solenoid completely (¼ turn beyond hand tight). Use the solenoid handle, which is specifically designed to shut the valve off completely and keep it from "weeping." Also tighten the bleed screw and bonnet screws. Use the external bleed screw to flush the valve. If performance does not improve, turn off water. Unscrew bonnet screws and remove bonnet. Remove diaphragm and clean it in clear water. Reinstall diaphragm and bonnet. If necessary, replace the diaphragm with kit number 210746-03.
Valve won't open.	Check water source, controller power, and flow control to make sure they are open. Turn off water. Unscrew bonnet screws and remove bonnet. Inspect body for debris. If filter is missing from diaphragm, replace diaphragm with kit number 210746-03. Turn off water. Remove solenoid and replace with a known working solenoid. If the valve still won't open, replace the solenoid.
Valve slams on / off (water hammer).	Check system water pressure. If pressure is greater than 80 psi (5,5 Bars), install a pressure regulator on the line before the valve to reduce water pressure.

NOTE: During winter shutdown, drain the system to protect DV valves from freezing. Failure to properly drain lines may damage the valves. Be sure to comply with all local guidelines.





Rain Bird Sales, Inc.

970 W. Sierra Madre Avenue
Azusa, CA 91702 USA
Tel. (626) 963-9311 Fax (626) 812-3411
Technical Services (USA only) (800) 247-3782

Rain Bird Sales, Inc.

6640 South Bonney Ave.
Tucson, AZ 85706 USA
Tel. (520) 741-6100 Fax (520) 741-6146
Specification Hotline (USA only) (800) 458-3005

Rain Bird International, Inc.

145 North Grand Avenue
Glendora, CA 91741 USA
Tel. (626) 963-9311 Fax (626) 963-4287

Rain Bird Europe S.A.R.L.

900, rue Ampère, BP 72000
13792 Aix-en-Provence CEDEX 3 - FRANCE
Tél. (33) 04 42 24 44 61 Tlx. 410094 Fax (33) 442 24 24 72

Rain Bird Deutschland GmbH

Siedlerstraße 46
D -71126 Gäufelden - Nebringen - DEUTSCHLAND
Tel. (49) 70 32 99010 Fax (49) 70 32 990111

Rain Bird Iberica S.A.

C/San Vicente nº3
28220 Majadahonda, Madrid - ESPAÑA
Tel. (91) 639 40 55 Fax (91) 639 52 98

© Copyright 2000 by Rain Bird Sprinkler Mfg. Corp.

® Registered trademark of Rain Bird Sprinkler Mfg. Corp.

www.rainbird.com



Printed in USA on recyclable paper.

P/N 231576-A